



- G5046** Eyewash/Drench Hose Unit, Wall Mounted
- G5046BP** Eyewash/Drench Hose Unit, Wall Mounted, with Backflow Preventer



APPLICATION: Dual purpose eyewash/drench hose for wall mounting. Unit meets the provisions of ANSI Z358.1-2009 as both an eyewash and a drench hose. Unit may be left in the mounting bracket for use as a fixed eyewash, leaving user's hands free. Alternatively, unit may be removed for use as a drench hose to rinse any part of user's eyes, face or body.

SPRAY HEAD ASSEMBLY: Two GS-Plus™ spray heads mounted side-by-side. Each head has a "flip top" dust cover, internal flow control and filter to remove impurities from the water flow.

VALVE: Forged brass squeeze valve activated by stainless steel lever handle. Valve has replaceable stainless steel seat for exceptional durability. Locking clip engages when handle is depressed, providing "hands free" operation. Valve stays open until locking clip is released.

HOSE: 12' reinforced nylon retractable coiled hose. 180 PSI maximum rated working pressure.

MOUNTING: Bracket with spring clips to hold unit on wall. Clips position spray heads and handle to face forward at all times.

BACKFLOW PREVENTER: In-line dual check backflow preventer installed on inlet of hose (G5046BP only). *Note: Check with code authority for compliance with local plumbing code.*

SUPPLY: 3/8" NPT female inlet.

SIGN: ANSI-compliant identification sign.

QUALITY ASSURANCE: Unit is completely assembled and water tested prior to shipment.

Available Options

- DC** Stainless steel dust cover for each spray head.
- VB** In-line vacuum breaker for installation between valve and spray head.
- TMV** G3600 thermostatic mixing valve precisely blends hot and cold water to deliver warm (tepid) water as provided by ANSI Z358.1-2009. Refer to "Tempering Units" section for complete technical and product selection information.





- **G5046** Eyewash/Drench Hose Unit, Wall Mounted
- **G5046BP** Eyewash/Drench Hose Unit, Wall Mounted, with Backflow Preventer

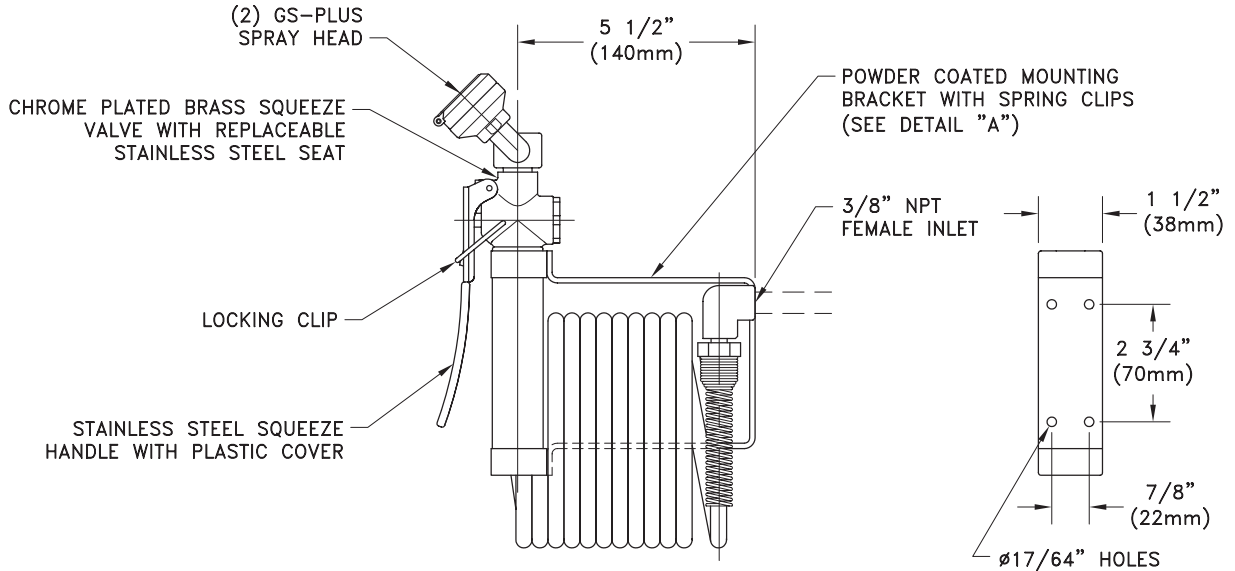

DETAIL "A"
MOUNTING BRACKET

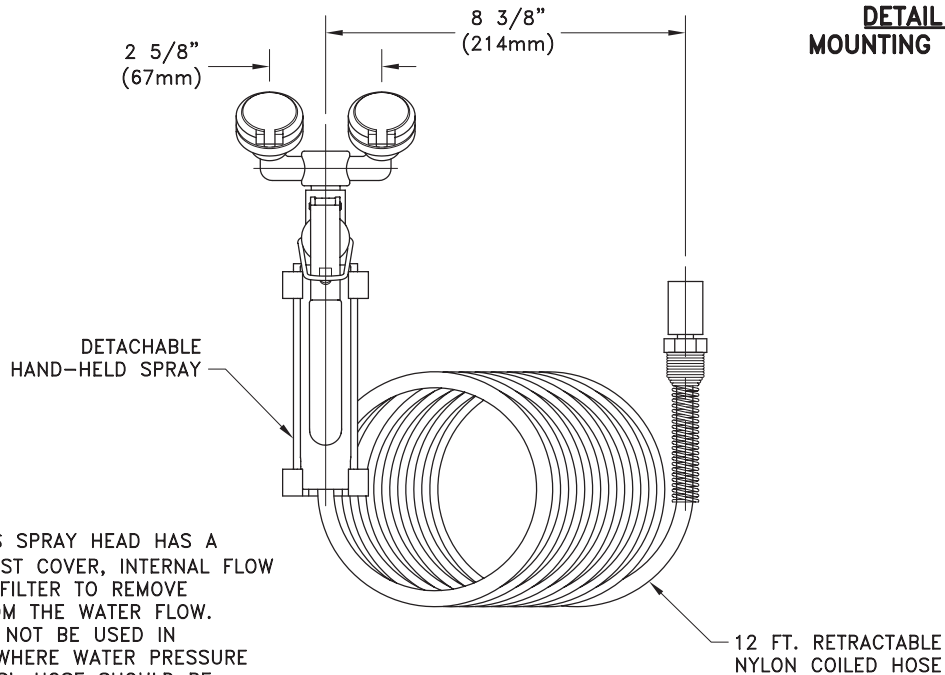

NOTES:

1. EACH GS-PLUS SPRAY HEAD HAS A "FLIP-TOP" DUST COVER, INTERNAL FLOW CONTROL AND FILTER TO REMOVE IMPURITIES FROM THE WATER FLOW.
2. HOSE SHOULD NOT BE USED IN APPLICATIONS WHERE WATER PRESSURE EXCEEDS 90 PSI. HOSE SHOULD BE INSPECTED PERIODICALLY FOR DETERIORATION.

THIS SPACE FOR ARCHITECT/ENGINEER APPROVAL

Due to continuing product improvement, the information contained in this document is subject to change without notice. All dimensions are ± 1/4" (6mm). rev. 0112

Sign Included

