



G1894 Eyewash, Pedestal Mounted, All-Stainless Steel

APPLICATION: Free standing, pedestal mounted eyewash. Constructed entirely in stainless steel. Ideal for use in highly corrosive environments and clean room applications. Two GS-Plus™ spray-type spray heads deliver a flood of water for rinsing eyes.

SPRAY HEAD ASSEMBLY: Two GS-Plus™ spray heads. Each head has a “flip top” dust cover, internal flow control and filter to remove impurities from the water flow.

VALVE: 1/2" IPS stainless steel stay-open ball valve. Valve has stainless steel ball and Teflon® seals.

BOWL: 11 1/2" diameter stainless steel.

PIPE AND FITTINGS: Schedule 40 stainless steel. Furnished with orange polyethylene covers for vertical piping for high visibility.

SUPPLY: 1/2" NPT female inlet.

WASTE: 1 1/4" NPT female outlet.

SIGN: ANSI-compliant identification sign.

QUALITY ASSURANCE: Valve, bowl and spray head assembly is factory assembled and water tested prior to shipment.

Available Options

- BC** Stainless steel bowl cover. Cover protects unit against contaminants. Cover is automatically raised when unit is activated.
- DC** Stainless steel dust cover for each spray head.
- HFC** Hand and foot control. Eyewash is activated by flag handle or foot treadle.
- HS** Auxiliary hand-held drench hose for rinsing eyes, face or body.
- TMV** G3600 thermostatic mixing valve precisely blends hot and cold water to deliver warm (tepid) water as required by ANSI Z358.1-2009. Refer to “Tempering Units” section for complete technical and product selection information.





□ G1894 Eyewash, Pedestal Mounted, All-Stainless Steel

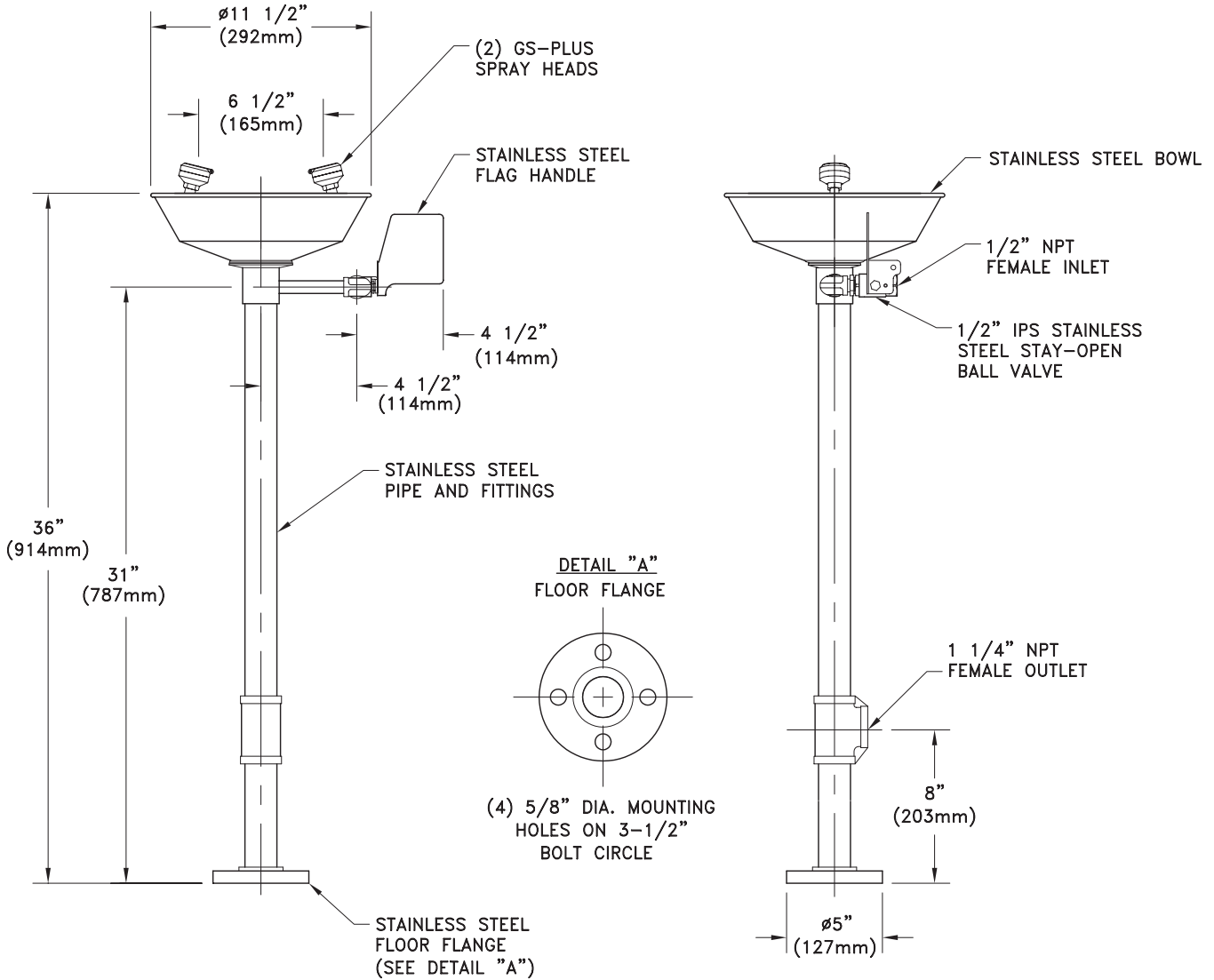

NOTE:
EACH GS-PLUS SPRAY HEAD HAS A "FLIP-TOP" DUST COVER, INTERNAL FLOW CONTROL AND FILTER TO REMOVE IMPURITIES FROM THE WATER FLOW.

THIS SPACE FOR ARCHITECT/ENGINEER APPROVAL

Due to continuing product improvement, the information contained in this document is subject to change without notice. All dimensions are $\pm 1/4"$ (6mm). rev. 0112

Sign Included

