



□ **G1814** Eyewash, Wall Mounted, Stainless Steel Bowl



APPLICATION: Eyewash for wall mounting. Two GS-Plus™ spray-type spray heads deliver a flood of water for rinsing eyes.

SPRAY HEAD ASSEMBLY: Two GS-Plus™ spray heads. Each head has a “flip top” dust cover, internal flow control and filter to remove impurities from the water flow.

VALVE: 1/2" IPS chrome plated brass stay-open ball valve. Valve is US-made with chrome plated brass ball and Teflon® seals.

BOWL: 11 1/2" diameter stainless steel.

MOUNTING: Heavy duty cast aluminum wall bracket with corrosion resistant powder coated finish.

SUPPLY: 1/2" NPT female inlet.

WASTE: 1 1/4" NPT female outlet.

SIGN: ANSI-compliant identification sign.

QUALITY ASSURANCE: Unit is completely assembled and water tested prior to shipment.

Available Options

- **BC** Stainless steel bowl cover. Cover protects unit against contaminants. Cover is automatically raised when unit is activated.
- **DC** Stainless steel dust cover for each spray head.
- **HS** Auxiliary hand-held drench hose for rinsing eyes, face or body.
- **SC** Self-closing ball valve. *Note: Eyewashes with self-closing valves do not comply with ANSI Z358.1-2009.*
- **T** Chrome plated brass tailpiece and trap with 1 1/2" IPS waste connection.
- **TP** 1 1/2" OD chrome plated brass tailpiece.
- **TMV** G3600 thermostatic mixing valve precisely blends hot and cold water to deliver warm (tepid) water as required by ANSI Z358.1-2009. Refer to “Tempering Units” section for complete technical and product selection information.





□ G1814 Eyewash, Wall Mounted, Stainless Steel Bowl

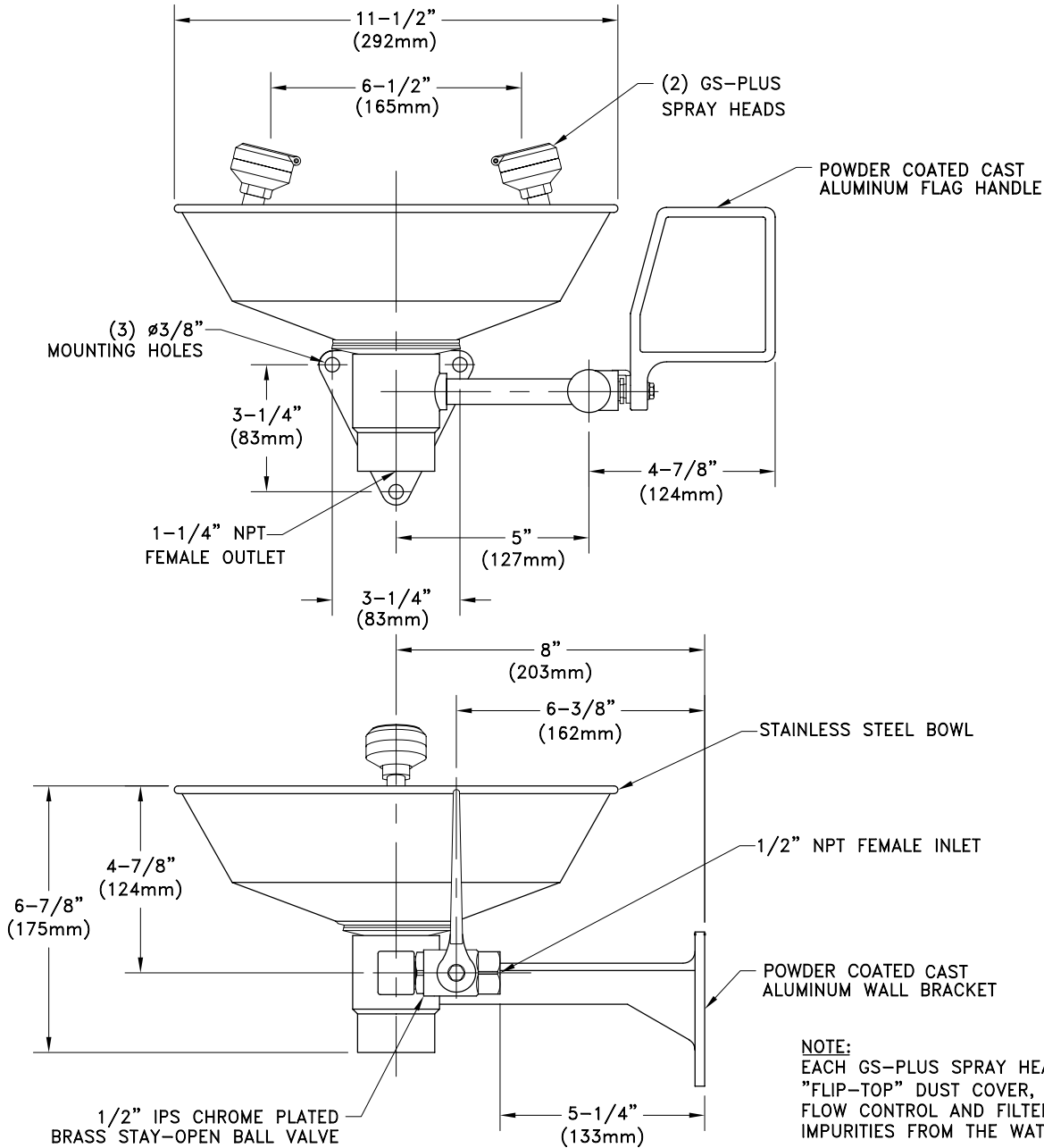

THIS SPACE FOR ARCHITECT/ENGINEER APPROVAL

Due to continuing product improvement, the information contained in this document is subject to change without notice. All dimensions are ± 1/4" (6mm). rev. 0112

Sign Included

