



□ G1771 Eye/Face Wash, Wall Mounted, Less Bowl



APPLICATION: Eye/face wash for wall mounting. Two large FS-Plus™ spray-type outlet heads deliver a flood of water for rinsing eyes and face. Unit is provided without bowl or drain for waste water. *Note: Floor drain should be provided underneath unit to prevent accumulation of water on floor.*

SPRAY HEAD ASSEMBLY: Two FS-Plus™ spray heads. Each head has a “flip top” dust cover, internal flow control and filter to remove impurities from the water flow.

VALVE: 1/2" IPS chrome plated brass stay-open ball valve. Valve is US-made with chrome plated brass ball and Teflon® seals.

MOUNTING: Heavy duty aluminum wall bracket with corrosion resistant powder coated finish.

CONSTRUCTION: Polished chrome plated brass.

SUPPLY: 1/2" NPT female inlet.

SIGN: ANSI-compliant identification sign.

QUALITY ASSURANCE: Unit is completely assembled and water tested prior to shipment.

Available Options

- **DC** Stainless steel dust cover for each spray head.
- **HS** Auxiliary hand-held drench hose for rinsing eyes, face or body.
- **SC** Self-closing ball valve. *Note: Eye/face washes with self-closing valves do not comply with ANSI Z358.1-2009.*
- **TMV** G3600 thermostatic mixing valve precisely blends hot and cold water to deliver warm (tepid) water as required by ANSI Z358.1-2009. Refer to “Tempering Units” section for complete technical and product selection information.



G1771 Eye/Face Wash, Wall Mounted, Less Bowl

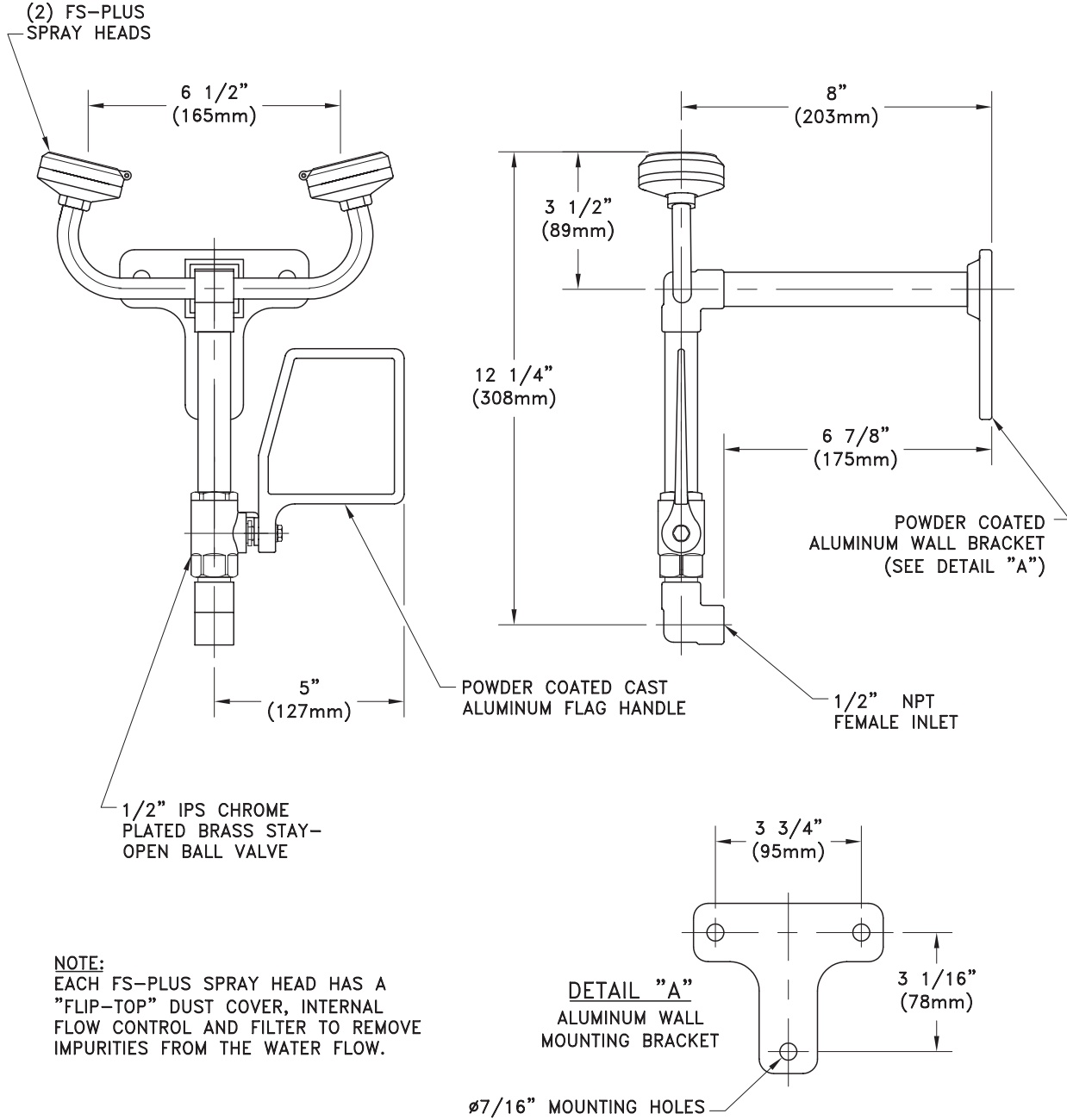

THIS SPACE FOR ARCHITECT/ENGINEER APPROVAL

Due to continuing product improvement, the information contained in this document is subject to change without notice. All dimensions are ± 1/4" (6mm). rev. 0112

Sign Included

